

4.



**SPARTAN  
EQUIPMENT®**

## **Professional Series Brush Cutter**



### **Owner's/Operator's Manual**

**⚠ WARNING**

*For safe operation, read these rules and instructions carefully to avoid accidents that could result in death or serious injury.*

**TO THE OWNER/OPERATOR OF THIS ATTACHMENT**

Please read this manual before unpacking or using this attachment for the first time. This manual provides you with the necessary instructions to safely install and use your purchase. Do not let other people use this attachment without first being instructed how to safely use it.



**Spartan Equipment**

Joppa, MD 21085

1.888.888.1085

*Save this manual for future reference!*

## Thank You

Our sincere appreciation to you on the purchase of a quality Professional Series Brush Cutter offered by Spartan Equipment.

Our record of successful and satisfied customers is evidence of the concern for quality and designed strength that we place into each and every product we build.

As this manual expresses the need for safe operation of your acquisition from Spartan Equipment, it is important that you and all operators of this attachment become familiar with the operation, maintenance and safety instructions found in this manual, as well as in the manual that accompanied the skid steer machine that will power this attachment. Add some common sense to the items mentioned in these manuals as the recipe for safe operation.

We invite you to look at more innovative products on our website at <http://www.spartanequipment.com>

Sincerely,  
Management & Employees  
Spartan Equipment

## Information

**Record product information here for future reference.**

Model 60" Professional Series \_\_\_\_  
72" Professional Series \_\_\_\_

S/N or MFG. Date \_\_\_\_\_

Dealer Name \_\_\_\_\_

Dealer Phone \_\_\_\_\_

Date of Purchase \_\_\_\_ / \_\_\_\_ / \_\_\_\_

# Table of Contents

5.

- Information ..... 2
- Orientation ..... 3
- Importance of Safety ..... 3
- Operator Safety Training Tips ..... 4
- Skid Steer Requirements ..... 5
- Unpacking Your Shipment ..... 5
- Using Your Attachment ..... 5
  - Connecting Cutter to Skid Steer ..... 5
  - Pre-Operation Walk-around
  - Inspection ..... 6
  - Cutter Boom Controls ..... 6
  - Engaging Cutter the First Time ..... 6
  - Starting the Cutter ..... 7
  - Stopping the Cutter ..... 7
  - Getting Familiar with the Attachment ..... 7
  - Adjusting Cutter Height & Level ..... 8
  - Before Cutting ..... 8
  - Cutting Tips ..... 8
- Maintaining your Attachment ..... 9
  - Before Every Use ..... 9
  - Every Week ..... 9
  - After Every Season ..... 10
  - Blade Removal & Replacement ..... 10
  - Blade Holder Removal & Installation ..... 11
  - Hydraulic System ..... 11
  - Hardware Torque ..... 11
- Specifications ..... 12
- Parts ..... 12
  - Standard Duty Cutter Parts ..... 13
  - Heavy Duty Cutter Parts ..... 14
  - Decals ..... 15
- Troubleshooting ..... 16

Limited Warranty ..... 17

## Orientation

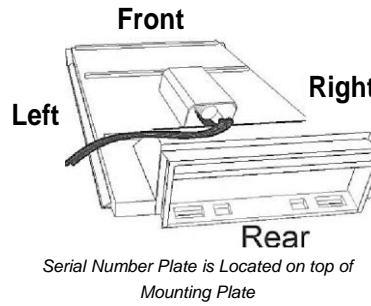

## Importance of Safety

Accidents can be very costly to human life and property. As the operator is the #1 safety device on all types of vehicles or equipment, it is important that the operator read, learn and know all safety recommendations for this product. The user is responsible to his family, friends and co-workers to operate in a safe manner. Ensure that everyone who operates or assists in the operation or maintenance of this product read and understand all the elements required to safely operate this piece of equipment.

This attachment has spinning blades that include additional dangers.

Throughout this manual you will find safety notes which are very important to read and understand before operating this piece of equipment. These classifications alert you to situations that could be harmful to you or bystanders. When you see these alerts in the manual, carefully read and follow all instructions and also protect other workers from the same danger.

 **DANGER** Will result in Death or Serious Injury.

 **WARNING** Could result in Death or Serious Injury.

 **CAUTION** Could result in Minor or Serious Injury.

 **NOTICE** Not related to Personal Injury.

## Operator Safety Training Tips

It is the responsibility of the operator using this attachment to be acquainted with the safe operation. In addition to reading this manual, it is important that the operator read the skid steer's operation manual and follow its manufacturer's recommendations!

 Before lifting or lowering the cutter, make sure the area is clear of bystanders or objects.

 Machinery parts sometimes have sharp edges. Wear work gloves when moving parts. Always use caution around cutter blades as they often are very sharp.

 Never use alcoholic drinks or drugs when operating or servicing this attachment.

 Always wear the proper personal protection equipment when servicing or operating this piece of equipment. Never service or operate this attachment with bare feet, sandals, or other light footwear.

 Always use eye protection during operation. Mount this attachment on a skid steer equipped with thermoplastic

polycarbonate door panel and side panels.

 **Speed Kills!** Operate this attachment at a safe working speed. When transporting the attachment, keep a safe speed to avoid losing control of the attachment or prime mover.

 Keep proper clearance between the attachment and objects (utilities, tree stumps, large rocks, buildings, etc.). Contacting these objects with the attachment or prime mover could cause a loss of control or damage to the attachment or property.

 Before each operation of this attachment, check all hardware (bolts, nuts, pins, etc.) for their proper location and tightness.

 Stop the engine on the skid steer and set the brake to avoid the attachment rolling forward or backwards while you are exiting the prime mover.

 Store this attachment in an area not frequented by children.

 Allow no riders on this attachment. Keep all bystanders clear of attachment during operation.

 Always replace worn, torn or missing safety decals before operating.

 Never operate the cutter when bystanders are within 75 feet (23 m) of the work area.

 Cut only during daylight or well-lit artificial light

## Skid Steer Requirements

The brush cutter should only be used on 50+ HP (37 kW) skid steers with a lift capacity of at least 1800 lbs. and with a weight of at least 5500 lbs. (2495 kg) with the bucket removed. A skid steer equipped with tracks will provide superior stability in this application.

To protect the operator from any flying debris, it is important that the skid steer should be equipped with a thermoplastic polycarbonate windshield or similar material, and similar protection on the sides of the operator's cab.

**CAUTION** *Make sure your skid steer is in good working condition. Follow the operating instructions found in the manual that accompanied your skid steer. Failure to do so could result in Minor or Serious Injury.*

## Unpacking Your Shipment

Your attachment arrives from the factory banded to a wooden pallet, and requires no final assembly before use.

**CAUTION** *Careless removal of the shipping bands that secure the attachment to the pallet could result in Minor or Serious Injury. Clear the area of all bystanders and stand to the side when cutting the bands with a pair of sheet metal shears.*

## Using Your Attachment

### Connecting Cutter to Skid Steer

**DANGER** *Never enter the area underneath the coupler or any part of the attachment when it is in the raised position to avoid an accident that will result in Death or Serious Injury.*

Verify that the hydraulic hoses are clear from the front of the attaching plate on the attachment and that the mounting plate is free from dirt and debris. When clear, move the skid steer to proximity of attachment plate. Tilt skid steer coupler forward to align coupling point with the upper part on the attachment plate and raise the coupler slightly.

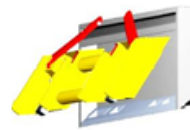

Connecting Coupler to Attachment

When the top edge of the coupler is seated in the top part of the coupler plate, roll the skid steer tilt function back until the attaching plate is flat against the skid steer coupler. Lock down the coupler levers. **Note:** If your skid steer is equipped with a hydraulically operated coupler, activate the coupler lock at this time.

**NOTICE** *Wipe off any dirt or dust from the male or female hydraulic flat-face couplers with a clean rag before attaching hoses, to keep contaminants from entering the hydraulic system.*

Connect the attachment hydraulic hoses to the auxiliary supply couplers located on your skid steer loader lift arm.

Attach the safety chain to a secure place <sup>6.</sup> on the skid steer unit to limit the height that the cutter can be raised.

Check the surrounding area for bystanders and clear them before starting the skid steer or attachment.

Before operating the attachment, always visually inspect and verify that the coupler lock pins are fully engaged through the latch slots on the attachment plate.

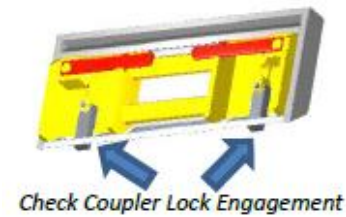

### Pre-Operation Walk-around Inspection

Before every use, it is important to perform a short inspection and certain maintenance on your brush cutter.

	Item
✓	Check that all shields and guards are in place.
✓	Look for loose bolts and tighten them if necessary.
✓	Check that all safety decals are in place and can be read. Replace them if necessary.
✓	Check that blades are in good condition. Sharpen or replace them, if necessary.
✓	Take care of our environment. Repair any hydraulic leaks.

## Cutter Boom Controls

Your brush cutter is designed to run off the skid steer loaders auxiliary hydraulic system, and is activated and deactivated by a control in the operator's cab. Consult your skid steer operator's manual for precise instructions on how to activate and deactivate the auxiliary circuit.

Height and tilt functions of the brush cutter are operated with the control handles or pedals in the cab. Consult your skid steers operator's manual for precise instructions regarding these functions.

### Engaging Cutter the First Time

**NOTICE** If this is your initial startup with this attachment on this machine, check the skid steer's hydraulic oil level and add oil, if necessary, before and after doing steps 1- 3 below.

After starting skid steer, lift the attachment 6" (152mm) off the ground surface:

1. With the skid steer engine RPMs just above idle, slowly engage the auxiliary hydraulic flow to the cutter head. Use your machine's auxiliary hydraulic flow lever or switch, activate the auxiliary flow to the brush cutter.
2. Allow the cutter to run for 30 seconds to purge the air from the system. Turn off the cutter drive, allowing it to come to a complete stop.
3. Lower the cutter attachment to the ground and shut off the skid steer's engine and exit the operator's compartment.

7. Check the skid steers hydraulic oil level, and add oil if necessary.
8. Inspect the cutter hydraulic plumbing for any noticeable leaks. Correct these leaks before continuing.
9. Restart the skid steer. With the attachment raised off the ground and the engine throttle set just above idle, engage the cutter drive circuit to start cutter. Allow cutter to come up to speed before increasing engine speed.

### Starting the Cutter

**⚠ WARNING** *Moving or engaging the cutter with bystanders in the area could result in Death or Serious Injury. Before engaging cutter hydraulics, always make sure the area is clear of bystanders.*

Engage the cutter drive hydraulics with the prime mover's engine at a low rpm. Slowly raise the skid steer engine's rpm to the correct and desired cutter speed. Use the skid steers's hand throttle to set the speed; never use a foot throttle when using the cutter.

**NOTICE** *If the cutter ever creates a vibration when ramping up speed, turn the cutter attachment to the off position and investigate cause. Refer today Troubleshooting section in this manual.*

### Stopping the Cutter

When stopping the cutter, raise the cutter slightly and lower the skid steer's engine RPMs to an idle, and allow the cutter to slow down. After the cutter has slowed down you may turn the auxiliary hydraulics to the "off" position.

## Getting Familiar with the Attachment

**⚠ DANGER** *Never operate the cutter when bystanders are within 75' (23 m) of your work area. Flying debris could result in Death or Serious Injury.*

**⚠ CAUTION** *Be cautious when operating on un-level ground surfaces. A machine roll over could result in Minor or Serious Injury. Always wear your seat belt when operating this type of machinery.*

Before starting the skid steer engine with this cutter attached, make sure you are knowledgeable and comfortable with the operation of the brush cutter controls as outlined in the previous and following sections of this manual.

**NOTICE** *Do not overspeed the cutter by allowing more than 20 GPM to the cutter head. This attachment requires 11-20 gallons of flow to cut efficiently.*

When operating the cutter, set the skid steer throttle at a speed that will produce the required flow. Refer to your skid steer manual or call your local skid steer dealer for additional help, if necessary. Your skid steer dealer can measure the flow available on your machine and recommend a throttle setting that is compatible with this attachment.

To begin with, learn what the cutter head looks like in a level cutting position when you are seated in the skid steer. Knowing what a level cutter head looks like will help you avoid damage to the cutting blades by cutting too close to the ground surface.

The correct ground speed for cutting with this attachment can be monitored by sound and feel and depends on the material density. If the skid steer engine is bogging down or if the cutter speed is turning too slow because of too much load, the ground speed should be decreased.

Listen and feel for any strange vibration when working the cutter. A bad vibration felt when cutting could indicate a damaged cutting blade, or material trying to be cut at too fast a pace. Slow down the skid steer's ground speed to see if vibration stops. If it does not, stop the cutter, turn off the skid steer engine and investigate cause of vibration. Refer to the Troubleshooting section in this manual for further instructions.

Always be aware of your surroundings. While watching the cutter, also pay attention to what obstacles or terrain are in front of the cutter and prime mover's wheels. Maintain a safe speed while cutting.

**CAUTION** *Cutting tree branches with the cutter in an elevated position could result in Death or Serious Injury if the skid steer becomes unstable. Never raise the cutter more a few feet off the ground when working on slopes or uneven terrain.*

### *Adjusting Cutter Height & Level*

Use the skid steer loader lift to adjust the elevation of the cutter. The fore & aft leveling can be accomplished by using the skid steer's attachment tilt cylinders.

**NOTICE** *When cutting dense or heavy material, you may*

*want to adjust the level of the cutter deck so the front of the cutter is approximately 1" (25mm) lower than the back of the cutter. This will assist the processing of the material and will avoid material "balling" under the deck.*

**CAUTION** *Use care when operating on uneven terrain or any type of sloped surface. Keep your cutter low to the ground when working in these conditions to avoid a roll over that could result in Minor or Serious Injury.*

### *Before Cutting*

Inspect the area to be cut and make sure it is free of any utilities, rocks, fence posts, or any other objects that you do not want to cut or that would damage the cutter.

Determine a safe cutting pattern before the start of the cut. Stop the forward progress of the skid steer loader.

Do not enter into an area to be cut before the cutter rotation come up to the operating speed.

### *Cutting Tips*

**CAUTION** *Never operate this attachment when bystanders are in proximity of the work area that could result in Minor or Serious Injury from flying debris.*

1. Always inspect work area before starting the cutter. Locate and mark any utilities, steel posts, rocks or any other objects that could be damaged or would damage the cutter during operation. Never assume the work area is safe and never skip



the inspection part before start of operation.

2. Operate at a safe slow-paced speed that will allow you to watch the area ahead of the cutter & loader.
3. Make sure you are operating the skid steer's engine at an rpm that will produce the volume of oil flow required for this attachment.

#### *Cutting Ground Level Vegetation*

4. Raise the rear of the brush cutter approximately 4" (102 mm) above ground level. The deck should be slightly sloping downward away from the operator.

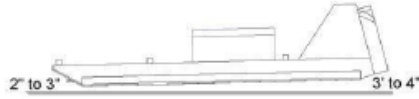

5. Your rotary brush cutter is capable of cutting and mulching small trees and other vegetation of up to 3" (76mm) in diameter. Learn and realize which way the tree is likely to fall so it does not end up crashing onto you in the skid steer.

**CAUTION** Do not operate the cutter if you (the operator) can see the cutter blade. If the operator can see the cutter blade, the back of the cutter is raised TOO HIGH and should be lowered to avoid debris being thrown back at the operator and causing Minor or Serious Injury.

#### *Cutting Above Ground Level Vegetation*

6. Tilt the front of the deck approximately 1 to 2 feet above ground level, but do not raise the rear of the deck. Drive slowly into the vegetation and use the hydraulic tilt to bend or push the vegetation forward. Allow the

cutter blade to cut the vegetation.

Lower the front of the deck as you continue to muck the material. Back drag the cutter to further minimize the size of the debris.

7. If the cutter speed slows down, reduced your travel speed and allow cutter to reach the proper rotating speed. Mowing too fast in thick material could result in balling of material underneath the cutter deck resulting in a loss of cutting efficiency.
8. Never use your cutter to push, pull, lift or move any type of object or vehicle. Do not use this attachment to "push" down trees without the cutter being used.
9. Always allow cutter to come up to operating speed before moving attachment into the material you want to cut.

## Maintaining your Attachment

### Before Every Use

Check that all fasteners (nuts, bolts, pins, keepers) are in their right place and are tight.

Inspect and replace any worn, torn or missing safety decals.

Investigate the location of any oil leaks and repair.

### Every Week

Check the condition of the blades by raising the cutter attachment off the ground and tilt the attachment forward to the 90° position. Lower the attachment to the ground.

Inspect the cutter blades and remove and sharpen them if necessary. Sharp

cutter blades will cut more efficiently than dull blades.

## After Every Season

Inspect the attachment for any loose or worn parts that may need to be replaced prior to the next cutting season.

Visually inspect the cutting blades. Sharpen or replace them, if necessary.

Clean, sand & repaint any area that looks worn or scratched to prevent further rusting. Use an equipment - paint found at your local hardware store or building center.

Store your attachment in a shed or cover with a water-proof tarp to protect it from the weather. Store in an area not frequented by children.

## Blade Removal & Replacement

**CAUTION** *Cutter blades can be very sharp and could cause Minor or Serious Injury if mishandled. Always wear protective gloves and footwear.*

### Blade Removal:

Carefully and slowly rotate the cutter blade carrier until the blade attaching nut is aligned with the access hole in the cutter deck. Insert a socket through the access hole to remove the blade nut, listening for the blade to fall off and hit the floor or ground. Repeat this process for the other blade(s).

Move the skid steer with cutter in reverse to retrieve the cutter blades from the floor or ground surface.

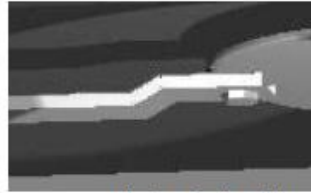

Blade & Blade Holder

### Blade Inspection:

**NOTICE** *Always service (sharpen or replace) the blades as a set. Never run the cutter with unmatched blades. Never install one used and one new blade as they will cause the cutter to be unbalanced and result in a vibration during operation and may cause harm to other cutter components.*

Sharpen the blades with the appropriate equipment, but be careful not to overheat the blade steel causing the blade material to become brittle and prone to early failure. Grind both blades to the similar shape and size being careful not to create a mismatched set of blades

### Blade Installation:

**WARNING** *To avoid an accident that could result in Death or Serious Injury, never find yourself in a position where any body part is located under an unsupported cutter deck when servicing this attachment.*

If possible, relocate the cutter deck in a position under an overhead hoist. Using a chain capable of lifting and supporting the weight of the entire cutter, sling the chain to lift up one end of the cutter to access the blades. If no hoist is available, use the skid steer to tilt the cutter head fully forward using the tilt function on the skid steer and position a 4" X 4" post of the appropriate length to use as a

security strut. Lower the cutter so the rear of the cutter is on the ground or floor surface. Some customers use a 10+'' tree and tilt the cutter back fully and rest it against the tree while installing the blades. Make sure to apply the skid steer brakes and/or place tire chocks to control any movement.

Insert the blade bolt up through the hole in the blade and the blade holder and insert the Lockwasher and nut through the access hole in the deck. Hand-tighten first, followed by applying a torque of 650 lb-ft. with a torque wrench.

Carefully remove the 4''x 4'' post.

### Blade Holder Removal & Installation

**Removal:**  
Tilt the skids steer's tool cylinder all the way back to place the attachment in a near vertical position. Secure the front of the cutter with a n overhead hoist or prop a 4'' x 4'' under the front or lean the cutter head against a large tree to support it in the raised position.

**CAUTION** *Be cautious during the following step. The blade cutter could fall resulting in Minor or Serious Injury. Stand to the side.*

Remove cap, cotter pin and castle nut that secure the holder to the gearbox shaft. If holder cannot be removed, start the skid steer and place the cutter level and jar the cutter on the floor or ground surface. The holder should separate from the gearbox flange. Repeat if necessary.

**Installation:**

**NOTICE** *Use a hoist, power jack or forklift to support the blade holder during installation*



Align the hole in the holder to gearbox shaft fully seat the holder on shaft. Tap with a hammer to assure full engagement. Make sure the holder is properly aligned and seated on gearbox shaft splines. Install castle nut, cotter pin and cap.

### Hydraulic System

**WARNING** *A small stream of oil from a pinhole leak could penetrate your skin if contacted. To avoid an accident that could result in Death or Serious Injury, never use your hand or other body parts in an attempt to locate a hydraulic leak.*

**NOTICE** *Always release the hydraulic system pressure from the cutter circuit prior to removing the attachment or any hydraulic system service work.*

### Hardware Torque

	Grade 2 lb-ft 	Grade 5 lb-ft 	Grade 8 lb-ft 
1/4''	66*	8	12
5/16''	10	17	20
3/8''	20	30	45
1/2''	45	75	110
3/4''	160	260	380
7/8''	190	400	600
1''	-	580	900

\* = inch pounds

Higher torques require the use of a torque multiplier. All values are "dry" torques.

## Specifications

Spec.	Model			
	60" SDBC	72" SDBC	60" HDBC	72" HDBC
Cut Width	57.5" (1461mm)	68.25" (1734 mm)	57.5" (1461 mm)	68.25" (1734 mm)
Weight	10501bs. (476kg)	1150lbs. (522kg)	10751bs. (488kg)	1175lbs. (533kg)
Blade Holder Weight with Blades	541bs. (25 kg)	581bs. (27 kg)	541bs. (25 kg)	581bs. (27 kg)
Min. Skid Steer Weight*	55001bs. (2495 kg)			
Min. Skid Steer Power	50 HP (37 kW)			
Min. Hyd. Flow	11 GPM (50 l/min)		20GPM (90 l/min)	
Max. Hyd. Flow	20GPM (90l/min)			
Hyd. Relief Setting	3000 PSI (207 bar)			
warranty	12 months			

\*A skid steer equipped with tracks will provide superior stability compared to a non-track unit.

## Parts

When requiring any parts for your attachment, please collect the following information:

Attachment Model Number  
Attachment Serial Number Cut  
Width  
Parts Manual Date (lower right corner)  
Parts Manual Page  
Part Description  
Quantity Required  
Ship-to Name & Address  
Payment Method

... then call Spartan Equipment for factory fresh parts specifically designed for your attachment.

## Standard Duty Cutter Parts

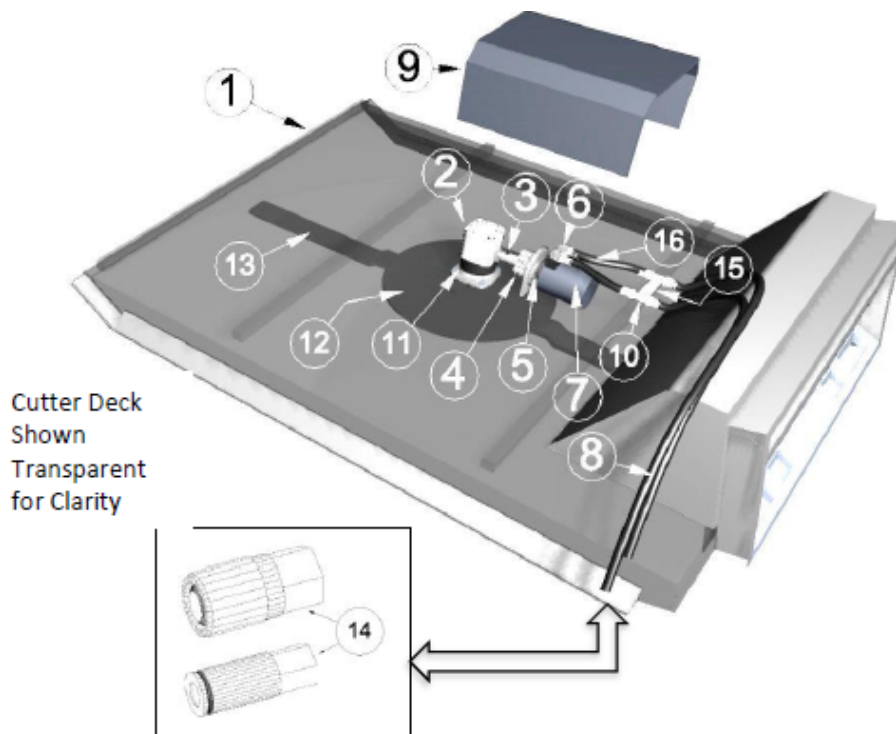

Ref.	Description	Qty.
1	Cutter Deck - Standard	1
	Cutter Deck – Open Front (Optional)	
2	Gearbox	1
3	Shear Bolt & Nut	1
4	Chain & Sprocket Set	1
5	Bolt & Nut (secures motor to cutter mounting plate)	2
6	Elbow	2
7	Hydraulic Motor	1
8	Hose	2
9	Cover	1
10	Tee	2
11	Bolt & Nut Set (Secures gearbox to cutter deck)	3
12	Blade Holder (Stump Jumper)	1
	Castle Nut	1
	Cap, Protective	1
13	Blade Set	1
	Blade Hardware Set	1
14	Quick Disconnect Set	1
15	One-Way Check Valve	1
16	Hose	2

10.

### Heavy Duty Cutter Parts

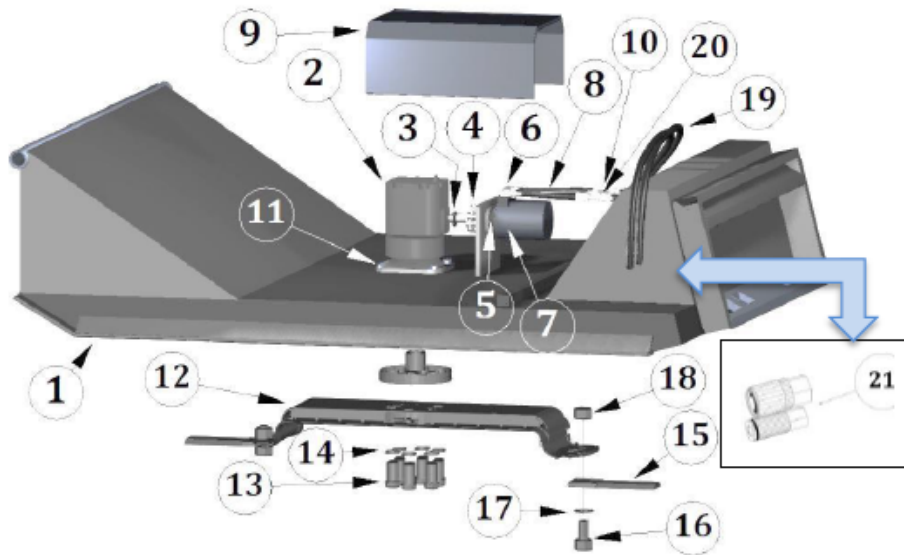

Ref.	Description	Qty.
1	Cutter Deck	1
2	Gearbox	1
3	Shear Bolt & Nut	1
4	Chain & Sprocket Set	1
5	Bolt & Nut (secures motor to cutter mounting plate)	2
6	Elbow	2
7	Hydraulic Motor	1
8	Hose	2
9	Cover	1
10	Tee	2
11	Bolt & Nut Set (Secures gearbox to cutter deck)	4
12	Blade Holder	1
13	Bolt	6
14	Washer	6
15	Blade	2
16	Bolt (Blade Retaining)	2
17	Spacer Washer	2
18	Nut	2
19	Hose (Tees to Quick Disconnects)	2
20	One-Way Check Valve	1
21	Quick Disconnect Set	1

## Decals

# 1 **/// DANGER STAY BACK ///**

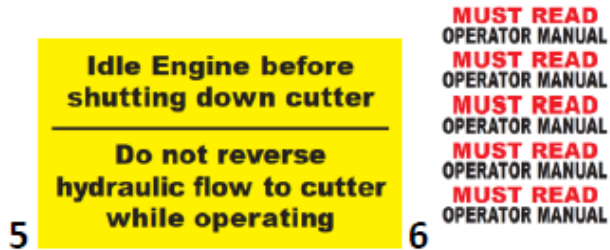

Ref.	Description	Qty.
1*	Decal, (Danger Stay Back)	2
2*	Decal, (Danger Pinch Points)	2
3*	Decal, (Warning, High Pressure Fluid Hazard)	1
4*	Decal, (Warning, Do Not Exceed 20 GPM)	1
5	Decal, Idle Engine Before Disengaging Cutter	1
6	Decal, Must Read Operator Manual	1

\*  **WARNING** Replace any worn, torn or missing safety decals before operating!

## Troubleshooting

Problem	Cause	Resolution
Cutter bogs down	Deck is not properly leveled & material is balling under deck	Refer to leveling instructions found in this manual.
	Dull blades	Remove and sharpen blades.
	Ground speed too fast	Slow down ground speed.
	Cutter speed too slow	Raise engine RPMs or investigate other low oil flow problem
Vibration felt when running cutter	Missing, loose, damaged or unbalanced cutter blades	Replace blades with new or re-sharpened and equally balanced blades.
	Blade mount damaged	Replace blade mount
	Gearbox loose on deck	Tighten & torque gearbox mounting bolts. Replace bolts if they are damaged.
	Cutting height too low for cutting in sandy or rocky soils	Raise cutter height.
Blades get dull too quickly	Blades have contacted solid objects (rocks, steel pipes, etc.)	Clear cutting area of solid objects before hitting them, or raise the cutter height to clear exposed rock surfaces.
Blades breaking	Excessive shock loads	Avoid hitting solid objects (rock, steel pipes, large tree stumps, etc.).
Hydraulic oil level goes down during operation	Leak at cutter motor or other plumbing	Investigate & repair
	Leaks in skid steer hydraulic system	Investigate & repair
Blades do not spin when flow is activated	Shear bolt between motor and gearbox is sheared	Replace with proper shear bolt specified for this unit.
	No oil Flow to attachment	Check that quick-disconnects are properly connected. Check skid steer auxiliary hydraulic system.
	Motor or gearbox failed	Disconnect the drive chain between motor & gearbox. If blade holder can be turned by hand, motor failure is suspect. Call your dealer for further recommendations.





**SPARTAN  
EQUIPMENT**

**Joppa, MD 21085**

## ***Owner's Manual***

### **Brush Cutter**

*Website*

[www.spartanequipment.com](http://www.spartanequipment.com)

*For More Information, Contact*

[contact@spartanequipment.com](mailto:contact@spartanequipment.com)

Phone: 1.888.888.1085

### **Limited Warranty**

Spartan Equipment products are warranted to be free from defects in workmanship or materials for period of (12) months from initial sale, lease or rental date.

#### Warranty Exclusions

This warranty does not cover normal wear items, including but not limited to, bearings, hoses, ground engaging parts such as, teeth, blades, cutting edges, pilot bits, auger teeth and broom bristles. This warranty does not cover maintenance, service or adjustments. This warranty does not cover damage due to misuse, negligence, accidents, or improper maintenance. This warranty does not cover damage due to improper application, installation, adjustment or setup. This warranty does not cover improper modifications of product. This warranty is void if any components have been disassembled, i.e. pumps, gear boxes, motors.

Specially modified attachments built by Spartan Equipment to meet your customer's needs shall not be warranted by Spartan Equipment.

This warranty does not cover replacement parts not supplied by Spartan Equipment.

#### Warranty Statement

Our obligation under this Limited Warranty shall be solely limited to repairing or replacing any part (see non-covered items) free of charge that, according to our judgment, show evidence of a defect in quality of workmanship or materials for the stated (12) month warranty period. All defective parts must be routed directly to Spartan Equipment with freight or delivery charges to be prepaid. This Limited Warranty shall not be interpreted to render Spartan Equipment liable for any injury or damage to persons, business or property of any kind nor expenses or losses incurred for labor, supplies, substitute machinery rental, or for any other reason. Repair or replacement parts are subject to the supply conditions at the time of repair or replacements, which may directly affect our ability to obtain material and/or replacements parts. Spartan Equipment reserves the right to make improvements in design or changes in specifications at any time without incurring any obligations to owners of previously purchased units. No one but Spartan Equipment is allowed to alter, modify or enlarge this warranty nor the exclusions, limitation and reservation at any time.