

4.



**SPARTAN
EQUIPMENT®**

Angle Brooms



Owner's/Operator's Manual

⚠ WARNING

For safe operation, read these rules and instructions carefully to avoid accidents that could result in Death or Serious Injury.

TO THE OWNER/OPERATOR OF THIS IMPLEMENT

Please read this manual "before" unpacking or using this implement for the first time. This manual provides you with the necessary instructions to safely install and use your purchase. Do not let other people use this attachment without first being instructed how to safely use it.



Spartan Equipment

Joppa, MD 21085

1-888-888-1085

Save this manual for future reference!

Thank You

Our sincere appreciation to you on the purchase of a quality Angle Broom offered by Spartan Equipment. Product experience of a combined 30 years is the cornerstone of our company, and our goal is to provide you with a heavy duty product that will give you years of satisfaction and operation.

Our record of successful and satisfied customers is evidence of the concern for quality and designed strength that we place into each and every product we build.

As this manual expresses the need for safe operation of your acquisition from Spartan Equipment it is important that you and all operators of this attachment become familiar with the operation, maintenance and safety instructions found in this manual, as well as in the manual that accompanied the skid steer machine that will power this attachment. Add some common sense to the items mentioned in these manuals as the recipe for safe operation.

We invite you to look at more innovative products on our web site:
<http://www.SpartanEquipment.com>.

Sincerely,
Management & Employees Spartan
Equipment

Information

Record product information here for future reference.

Model (v') Angle Broom

Manual Angle ___

Hydraulic Angle ___

S/N or MFG. Date _____ _

Dealer Name _____ _

Dealer Phone _____ _

Date of Purchase ___ / ___j

—

Table of Contents

Thank You	2
Information	2
Orientation	3
Importance of Safety	3
Operator Safety Training Tips	4
Skid Steer Requirements	5
Unpacking Your Shipment	5
Using Your Attachment	5
Connecting Broom to Skid Steer	5
Pre-Operation Walk-around	
Inspection	6
Broom Controls	6
Engaging Broom the First Time	7
Stopping the Broom	7
Getting Familiar with the	
Attachment	7
Adjusting Broom Height & Level	8
Angling the Broom	8
Starting the Job	8
Sweeping Tips	9
Maintaining your Attachment	10
Modifications	10
Before Every Use	10
Every Week	10
After Every Season	10
Hydraulic System	10
Hardware Torque	10
Parts	11
Manual Angle Broom Parts	12
Hydraulic Parts (Power Angle	
Models Only)	13
Decals	14
Troubleshooting	15
Specifications	16

Hydraulic/Electrical Drawing (Hyd.	
Angle)	17
Limited Warranty	20

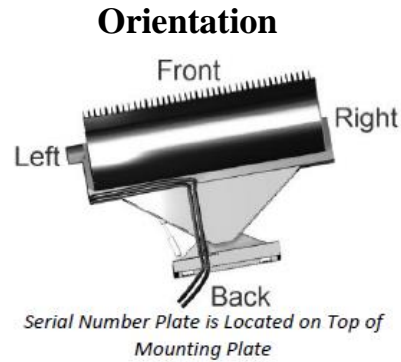

Importance of Safety

Accidents can be very costly to human life and property. As the operator is the #1 safety device on all types of vehicles or equipment, it is important that the operator read, learn and know all safety recommendations for this product. The user is responsible to his family, friends and co-workers to operate in a safe manner. Ensure that everyone who operates or assists in the operation or maintenance of this product read and understand all the elements required to safely operate this piece of equipment.

This attachment has moving parts that include additional dangers.

Throughout this manual you will find safety notes which are very important to read and understand before operating this piece of equipment. These classifications alert you to situations that could be harmful to you or bystanders. When you see these alerts in the manual, carefully read and follow all instructions and also protect other workers from the same danger.

 **DANGER** Will result in Death or Serious Injury.

 **WARNING** Could result in Death or Serious Injury.

 **CAUTION** Could result in Minor or Serious Injury.

 **NOTICE** Not related to Personal Injury.

Operator Safety Training Tips

It is the responsibility of the operator using this attachment to be acquainted with the safe operation. In addition to reading this manual, it is important that the operator read the skid steer's operation manual and follow its manufacturer's recommendations!

 Before lifting or lowering the broom, make sure the area is clear of bystanders or objects.

 Machinery parts sometimes have sharp edges. Wear work gloves when moving parts. Always use caution around the broom's bristles as it may have a sharp edge.

 Never use drugs or alcoholic drinks when operating or servicing this piece of equipment.

 Always wear the proper personal protection equipment when servicing or operating this piece of equipment. Never service or operate this attachment with bare feet, sandals, or other light footwear.

 Always use eye protection during operation. Mount this attachment on a

skid steer equipped with thermoplastic polycarbonate door panel and side panels.

 Speed Kills! Operate this attachment at a safe working speed. When transporting the attachment, keep a safe speed to avoid losing control of the attachment or prime mover.

 Keep proper clearance between the attachment and objects (utilities, tree stumps, large rocks, buildings, etc.). Contacting these objects with the attachment or prime mover could cause a loss of control or damage to the attachment or property.

 Never attempt to operate this attachment from anywhere but when seated in the prime mover's operators seat.

 Stop the engine on the skid steer and set the brake to avoid the attachment rolling forward or backwards while you are exiting the prime mover.

 Store this attachment in an area not frequented by children.

 Allow no riders on this attachment. Keep all bystanders clear of attachment during operation.

 Always replace worn, torn or missing safety decals before operating.

 Never operate the broom when bystanders are within 100 feet (30 m) of the work area.

 Sweep only during daylight or well-lit artificial light.

Skid Steer Requirements

Your Angle Broom must only be used on a skid steer unit with a compatible attachment coupler.

To protect the operator from any flying debris, it is important that the skid steer should be equipped with a thermoplastic polycarbonate windshield or similar material, and similar protection on the sides of the operator's cab.

CAUTION *Make sure your skid steer is in good working condition. Follow the operating instructions found in the manual that accompanied your skid steer. Failure to do so could result in Minor or Serious Injury.*

Unpacking Your Shipment

Your attachment arrives from the factory banded to a wooden pallet, and requires no final assembly before use.

CAUTION *Careless removal of the shipping bands that secure the attachment to the pallet could result in Minor or Serious Injury. Clear the area of all bystanders and stand to the side when cutting the bands with a pair of sheet metal shears.*

Using Your Attachment

Connecting Broom to Skid Steer

DANGER *Never enter the area underneath the coupler or any part of the attachment when it is in the raised position to avoid an accident that will result in Death or Serious Injury.*

Verify that the hydraulic hoses are clear from the front of the attaching plate on the attachment and that the mounting plate is free from dirt and debris. When clear, move the skid steer to proximity of attachment plate. Tilt skid steer coupler forward to align coupling point with the upper part on the back of the attachment plate and raise the coupler slightly.



Connecting Coupler to Attachment

When the top edge of the coupler is seated in the top part of the coupler plate, roll the skid steer tilt function back until the attaching plate is flat against the skid steer coupler. Lock down the coupler levers. **Note:** If your skid steer is equipped with a hydraulically operated coupler, activate the coupler lock at this time. Shut the Skid steer's engine off and release the pressure in the auxiliary circuit.

NOTICE *Wipe off any dirt or dust from the male or female hydraulic flat-face couplers with a clean rag before attaching hoses to keep contaminants from entering the hydraulic system.*

Connect the attachment hydraulic hoses to the auxiliary supply couplers located on your skid steer loader lift arm. If your broom is equipped with the hydraulic angle feature, attach the electrical harness to the appropriate 12 volt source on the skid steer and place the switch in the operator's compartment. There is a magnet on the back of the switch box to allow you to place the switch at a location of your choice, inside the cab.



Connect Wire Harness on Model with Hydraulic Angle (only)

Check the surrounding area for bystanders and clear them before starting the skid steer or attachment.

Before operating the attachment, always visually inspect and verify that the coupler lock pins are fully engaged through the latch slots on the attachment plate.

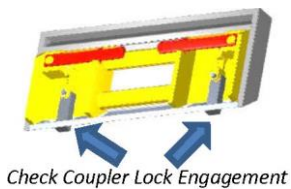

Pre-Operation Walk-around Inspection

Before every use, it is important to perform a short inspection and certain maintenance on your broom

	Item
✓	Check that all shields and guards are in place.
✓	Look for loose bolts and tighten them if necessary.
✓	Check that all safety decals are in place and can be read. Replace them if necessary.
✓	Take care of our environment. Repair any hydraulic leaks.

Broom Controls

Your Angle Broom is designed to operate by the skid steer's auxiliary hydraulic system, and is operated by a control in the operator's cab. Consult your skid steer operator's manual for precise instructions on how to activate and deactivate the auxiliary circuit.

Height and tilt functions of the broom are operated with the control handles or pedals in the cab. Consult your skid steers operator's manual for precise instructions regarding these functions.

Engaging Broom the First Time

NOTICE If this is your initial startup with this attachment on this machine, check the skid steer's hydraulic oil level and add oil, if necessary, before and after doing steps 1- 3 below.

After starting the skid steer, lift the attachment 6" (152mm) off the ground surface:

1. With the skid steer engine RPMs just above idle, slowly engage the auxiliary hydraulic to spin the broom bristles. Move the auxiliary control pedal, lever or switch in the opposite directions to reverse the broom's direction. Repeat this three times.
2. If your broom is equipped with the hydraulically operated angle feature, operate that function in both directions three times also.
3. Lower the broom attachment to the ground and shut off the skid steer's engine and exit the operator's compartment.

NOTICE Do not store the broom while it is resting on the bristles as the weight of the attachment over time will warp or distort the shape of the bristles.

5. Check the skid steers hydraulic oil level, and add oil if necessary.
6. Inspect the broom's hydraulic plumbing for any noticeable leaks. Correct these leaks before continuing.

Stopping the Broom

The broom quits moving when the auxiliary control is neutralized. When

7.

you are done sweeping for a period of time, always rest the broom attachment on the brackets designed to support the weight of

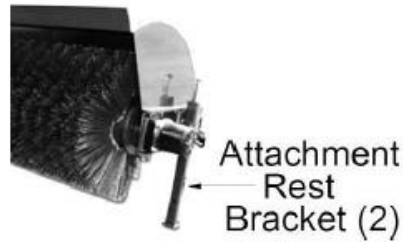

To raise the rest brackets, take the weight off the rests by lifting slightly on the broom. Pull the lock pin out of the rest bracket

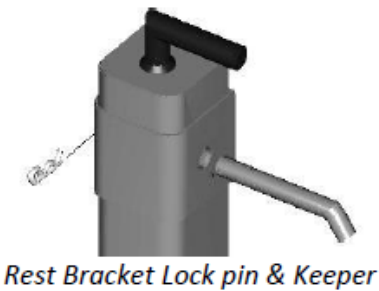

Getting Familiar with the Attachment

DANGER Never operate the broom when bystanders are within 100' (30 m) of your work area. Flying debris could result in Death or Serious Injury.

CAUTION Be cautious when operating on un-level ground surfaces. A machine roll over could result in Minor or Serious Injury. Always wear your seat belt when operating this type of machinery.

Before starting the skid steer engine with this broom attached, make sure you are knowledgeable and comfortable with the operation of the broom controls as outlined in the previous and following sections of this manual.

To begin with, learn what the broom looks like in a level sweeping position when you are seated in the skid steer. Knowing what a level broom head looks like will help you maximize the efficiency of the broom.

Always be aware of your surroundings. While watching the broom, also pay attention to what obstacles or terrain are in front, sides of the broom and prime mover's wheels.

CAUTION *Tilting a spinning broom too far forward in an elevated position could result in Minor or Serious Injury if debris from the broom is thrown towards the operator.*



Broom Tilt Caution

Always operate the broom in a horizontal position.

Adjusting Broom Height & Level

Use the skid steer loader lift to adjust the elevation of the broom

attachment. The fore & aft leveling can be accomplished by using the skid steer's attachment tilt cylinders.

Angling the Broom

Manual Angle Models: Raise the attachment about 8" (200 mm) off the ground surface. Shut off the skid steer engine

1. Exit the cab and remove the angle- lock pin located in the center of the broom mounting bracket.
2. When the lock pin has been pulled, the broom head can be pivoted to the desired angle.
3. Insert the pin to lock the broom head in place.

Hydraulic Angle Models: Raise the broom off the ground surface about 8" (200 mm).

1. Engage the broom bristle rotation at a slow engine speed and activate the toggle switch to move the broom angle to the desired position.

Starting the Job

DANGER *Never operate this attachment in the proximity of any utilities laying on the ground surface. Always inspect area before starting the sweeping process to avoid any electrical wires or cables that might be laying on the surface.*

WARNING *Moving or engaging the broom with bystanders in the area could result in Death or Serious Injury. Before engaging the broom hydraulics, always make sure the area is clear of bystanders.*

Before operating this attachment, always visually inspect the surrounding area for any objects that could be damaged if contacted.

⚠ WARNING *Exposure to crystalline silica dust along with other hazardous dusts may cause serious or fatal respiratory disease. It is recommended to use personal protective equipment during the operation of any attachment that may cause a high level of dust.*

(If the broom has been placed on the two rest brackets (on left & right side), lift the broom slightly, turn off the skid steer, and raise the brackets before starting your task.)

1. Position the desired angle as previously outline in this manual.
2. Position the broom's bristles about 2" (51 mm) above the surface to be swept and engage the skid steer's auxiliary hydraulic circuit. Notice the direction of the bristle rotation and if not correct, reverse the flow by selecting the opposite direction on the auxiliary circuit switch, pedal or lever.
3. Allow the broom's bristle rotation to come up to speed before raising the engine RPMs on the skid steer.
4. Rest the broom on the surface to be swept and move the skid steer in the forward direction at a speed no faster than 6 MPH (9.6 km/h).

NOTICE *Excessive downward pressure on the broom will accelerate bristle wear and will not result in better sweeping efficiency.*



Excessive Down Pressure Correct Down Pressure

Sweeping Tips

⚠ CAUTION *Never operate this attachment when bystanders are in proximity of the work area that could result in Minor or Serious Injury from flying debris.*

⚠ CAUTION *Use care when operating on uneven terrain or any type of sloped surface. Keep your broom low to the ground when working in these conditions to avoid a roll over that could result in Minor or Serious Injury.*

1. Operate at a safe pace that will allow you to watch the area around the broom & loader.
2. Never use your broom to push, pull, lift or move any type of object or vehicle.
3. Your attachment is not to be used as a dozer blade to move large piles of material.
4. Occasionally, clean out any limbs, vines, twine or trash that may accumulate around the broom's bristles.
5. Avoid exiting the skid steer cab with the broom in the raised position. Never walk or lay under the attachment in a raised position, or allow any bystander to do so.

Maintaining your Attachment

Modifications

Modifications to the original design by the end user may result in weakening the designed structure and integrity of this attachment and will void any warranty.

Before Every Use

Check that all fasteners (nuts, bolts, pins, keepers) are in their right place and are tight.

Lubricate all pivot joints using #2 lithium grease.

Inspect and replace any worn, torn or missing safety decals.

Investigate the location of any oil leaks and repair.

Every Week

Check the condition of the sweeper wafers.

Lubricate all grease able pivot joints.

After Every Season

Inspect the attachment for any loose or worn parts that may need to be replaced prior to the next season.

Visually inspect the sweeper wafers. Replace wafers as a set, if necessary.

Clean, sand & repaint any area that looks worn or scratched to prevent further rusting. Use an equipment paint found at your local hardware store or building center.



Lubricate all the pivot joints before storage. If storing in a saltwater environment, apply grease to the exposed chrome cylinder rod(s). Store your attachment in a shed or cover with a water-proof tarp to protect it from the weather. Store in an area not frequented by children.

Hydraulic System

WARNING A small stream of oil from a pinhole leak could penetrate your skin if contacted. To avoid an accident that could result in Death or Serious Injury, never use your hand or other body parts in an attempt to locate a hydraulic leak.

NOTICE Always release the hydraulic system pressure from the attachment circuit prior to removing the attachment or any hydraulic system service work.

Be kind to the environment. Repair any hydraulic leaks immediately!

	Grade 2 lb-ft	Grade 5 lb-ft	Grade 8 lb-ft
			
¼"	66*	8	12
5/16"	10	17	20
3/8"	20	30	45
½"	45	75	110
¾"	160	260	380
7/8"	190	400	600
1"	-	580	900

* = inch pounds

All values are "dry" torques.

Parts

When requiring any parts for your attachment, please collect the following information:

Attachment Model Number

Attachment Serial Number

Broom Width

Parts Manual Date (lower right corner)

Parts Manual Page

Part Description

Quantity Required

Ship-to Name & Address

Payment Method

... then call your local dealer for factory fresh parts specifically designed for your attachment.

**Use Genuine Parts
from Spartan
Equipment**

Manual Angle Broom Parts

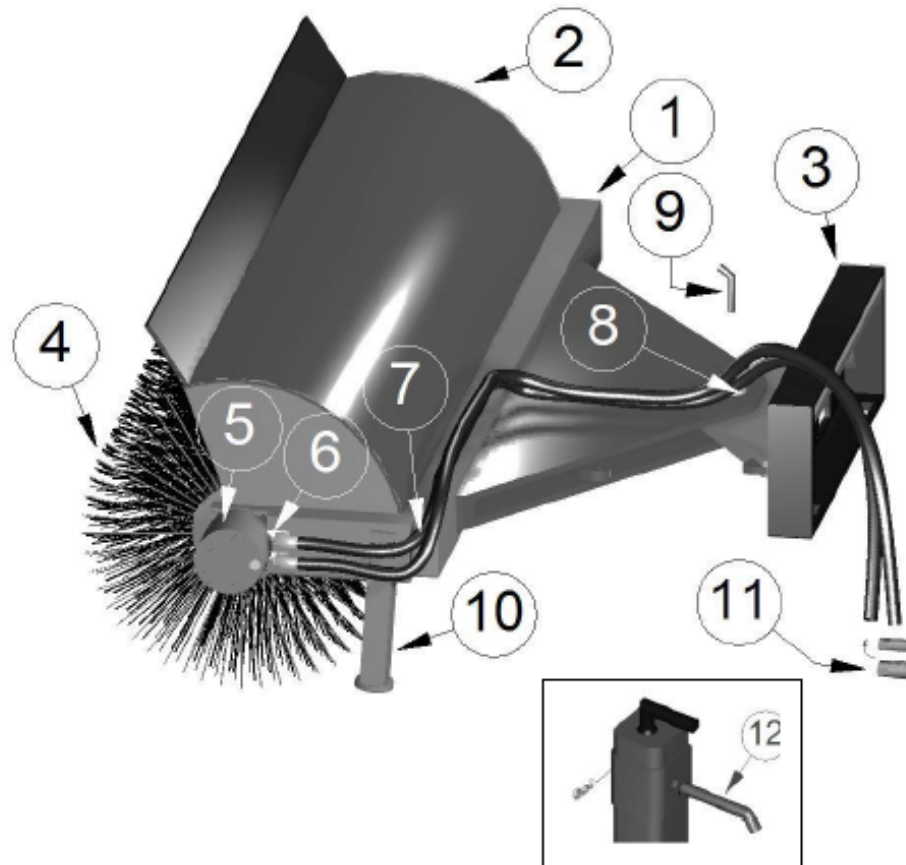

Ref.	Description	Quantity Per Unit			
		48"	60"	72"	84"
1	Main Frame	1	1	1	1
2	Hood	1	1	1	1
3	Attachment Plate	1	1	1	1
4	Bristle Assembly (Specify Steel or Poly)	1	1	1	1
5	Motor	1	1	1	1
6	90° Fitting	2	2	2	2
7	Hose	2	2	2	2
8	Pin, Angle Pivot	1	1	1	1
9	Pin, Angle Lock	1	1	1	1
10	Support Assembly	2	2	2	2
11	Couplers, Hyd. Flat-face (Set)	1	1	1	1
12	Pin & Keeper (Rest Support)	2	2	2	2
NS	Hose Protector Sleeve	1	1	1	1

Hydraulic Parts (Power Angle Models Only)

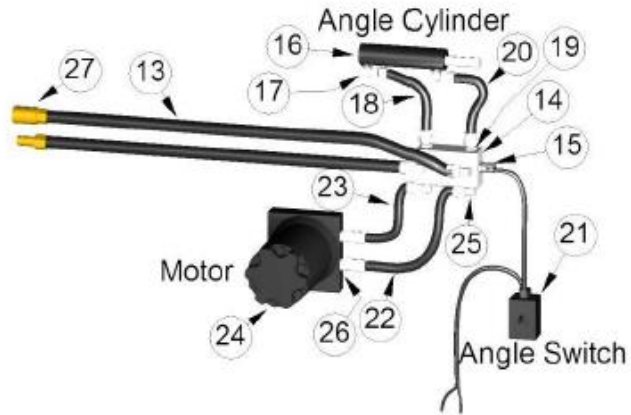

Ref.	Description	Qty.
13	Hose Set (Skid Steer to Angle Valve)	1
14	Valve, Angle Selection	1
15	Solenoid Valve	1
16	Cylinder (Angle)	1
17	Fitting, 90°	2
18	Hose (Valve to Cylinder)	1
19	Fitting, Adapter	2
20	Hose (Valve to Cylinder)	1
21	Control Switch Assembly	1
22	Hose (Valve to Motor)	1
23	Hose (Valve to Motor)	1
24	Motor	1
25	Fitting, 90°	2
26	Fitting, 90°	2

Decals



Ref.	Description	Qty.
1*	Decal, (Danger Pinch Points)	2
2*	Decal, (Warning, High Pressure Fluid Hazard)	1
3	Decal, Must Read Operator Manual	1

*  **WARNING** *Replace any worn, torn or missing safety decals before operating!*

Troubleshooting

Problem	Cause	Resolution
Skid steer hydraulic oil level goes down during operation	Leak between skid steer and attachment motor or cylinder	Investigate & repair
	Leaks in skid steer hydraulic system	Investigate & repair
Hydraulic angle does not move (Hyd. Angle Models Only)	Valve not shifting due to solenoid failure	Shut off skid steer and release pressure in the auxiliary circuit. Remove the shift cartridge and check if a contaminant is blocking the valve action. Check if solenoid coil is working.
	Solenoid valve not receiving signal from switch in cab	Verify that the 12V positive lead is connected to a live circuit and that the ground circuit is good.
		Disconnected or shorted wire in wire harness, solenoid valve or harness coupler.
	Malfunctioning solenoid valve cartridge.	
Broom does not turn	Incomplete circuit to and from motor	Either one of the hydraulic couplers is not fully engaged. Disconnect and reconnect hoses to machine.
	Motor contaminated	Drive motor failure. Replace motor after flushing/cleaning hose interiors.

Specifications

	48"		60"		72"		84"	
Angle	Manual	Hyd.	Manual	Hyd.	Manual	Hyd.	Manual	Hyd.
Sweep Width	48" (1218mm)		60" (1524mm)		72" (1829mm)		84" (2134mm)	
Overall Width	60" (1524mm)		72" (1829mm)		84" (2134mm)		96" (2438mm)	
Weight Lbs. (kg)	695 (315)	750 (340)	755 (342)	820 (372)	815 (370)	890 (404)	875 (397)	950 (431)
Max. Angle	22.6°							
Length (Front to Back)	62" (1575mm)							
Height	30" (762mm)							
Max. Operating Pressure	3000 PSI (207 bar)							
Rec. Hydraulic Flow	11-20 GPM (42 -75 L/min)							
Cylinder Size	3" X 6" (76mm X 152mm)							

Hydraulic/Electrical Drawing (Hyd. Angle)

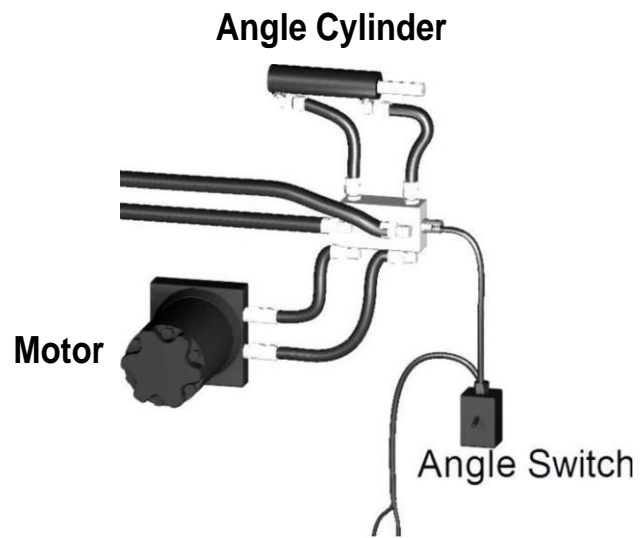

Accidents, Big or Small, Avoid Them All!



**SPARTAN
EQUIPMENT**

Joppa, MD 21085

Owner's Manual **Angle Brooms**

Website

www.SpartanEquipment.com

For More Information, Contact

contact@Spartanequipment.com

Phone: 1-888-888-1085

Limited Warranty

Spartan Equipment products are warranted to be free from defects in workmanship or materials for period of (12) months from initial sale, lease or rental date.

Warranty Exclusions

This warranty does not cover normal wear items, including but not limited to, bearings, hoses, ground engaging parts such as, teeth, blades, cutting edges, pilot bits, auger teeth and broom bristles. This warranty does not cover maintenance, service or adjustments. This warranty does not cover damage due to misuse, negligence, accidents, or improper maintenance. This warranty does not cover damage due to improper application, installation, adjustment or setup. This warranty does not cover improper modifications of product. This warranty is void if any components have been disassembled, i.e. pumps, gear boxes, motors.

Specially modified attachments built by SPARTAN EQUIPMENT to meet your customer's needs shall not be warranted by Spartan Equipment, Inc.

This warranty does not cover replacement parts not supplied by SPARTAN EQUIPMENT.

Warranty Statement

Our obligation under this Limited Warranty shall be solely limited to repairing or replacing any part (see non-covered items) free of charge that, according to our judgment, show evidence of a defect in quality of workmanship or materials for the stated (12) month warranty period. All defective parts must be routed directly to SPARTAN EQUIPMENT with freight or delivery charges to be prepaid. This Limited Warranty shall not be interpreted to render SPARTAN EQUIPMENT liable for any injury or damage to persons, business or property of any kind nor expenses or losses incurred for labor, supplies, substitute machinery rental, or for any other reason. Repair or replacement parts are subject to the supply conditions at the time of repair or replacements, which may directly affect our ability to obtain material and/or replacements parts. SPARTAN EQUIPMENT reserves the right to make improvements in design or changes in specifications at any time without incurring any obligations to owners of previously purchased units. No one but SPARTAN EQUIPMENT is allowed to alter, modify or enlarge this warranty nor the exclusions, limitation and reservation at any time.